



# **ISUOG Basic Training**

## **Physical Principles of Ultrasound including Safety**



# **ISUOG Basic Training**

## **Physical Principles of Ultrasound including Safety**

# Learning objectives

At the end of the lecture you will be able to:

- Explain how an ultrasound image is generated
- Describe the different ultrasound modes used for imaging
- Describe the current international safety standards relating to the thermal index (TI) and the mechanical index (MI)

# Key questions

1. What is ultrasound?
2. How is a B-mode real time image produced?
3. How should the ALARA principle be applied?

# Sound/Ultrasound

- Longitudinal mechanical wave
- Transmitted through medium by local displacement of particles within medium – compression & rarefaction
- Frequency (Hertz) = cycles/sec
- Human audible range = 20Hz – 20,000Hz (20kHz)
- Ultrasound = frequencies above audible range

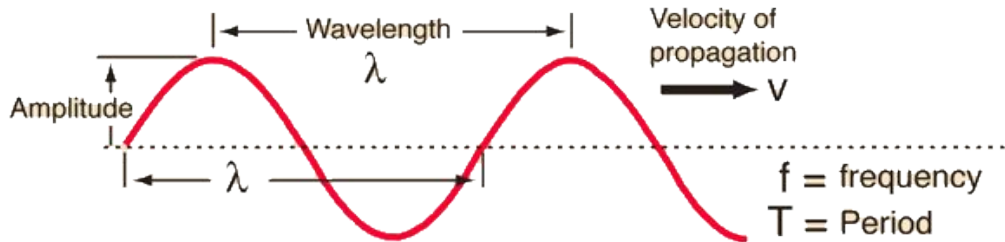

# Sound

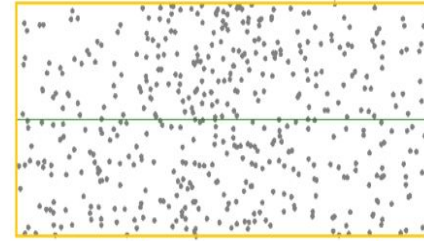

- Compressional wave
- Gas, liquid or solid medium
- Speed of sound depends on medium and temperature
  - Air 343 m/s
  - Water 1482 m/s
  - Steel 5960 m/s
  - **Average in biological tissue 1540 m/s**

# Physics of sound

- Medical US ~ 1 – 20 MHz

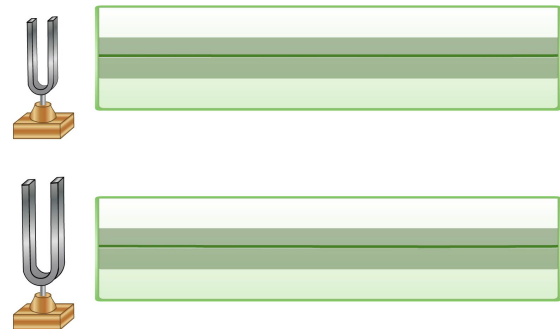
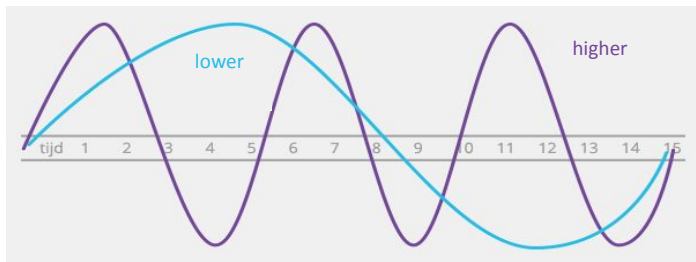
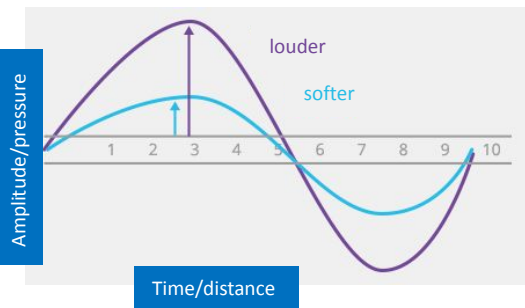
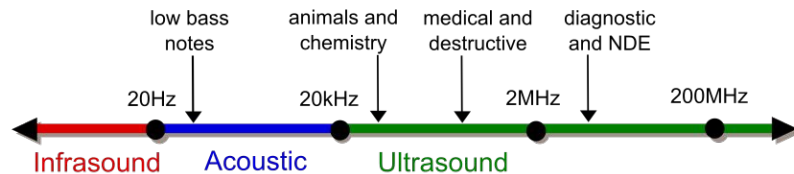
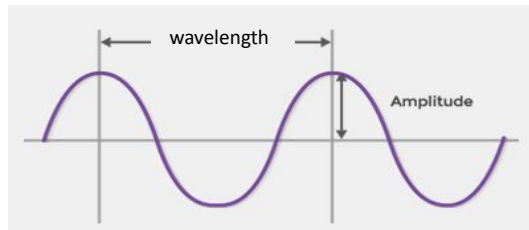

# From US to image

- Piezoelectric effect – ability to generate (transduce) electrical charge in response to applied mechanical stress, & vice versa
- Piezoelectric crystal - quartz, zirconium titanate, modern ceramics

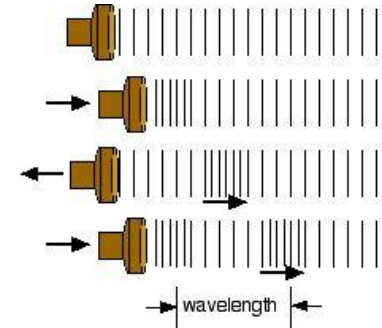
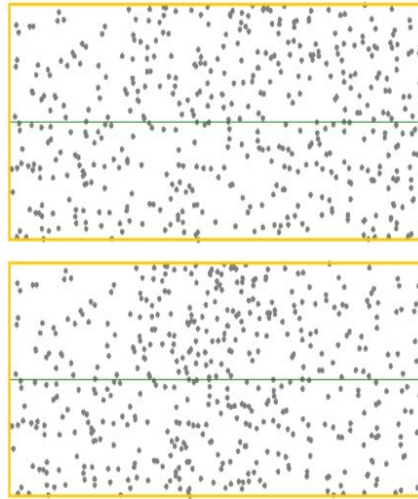
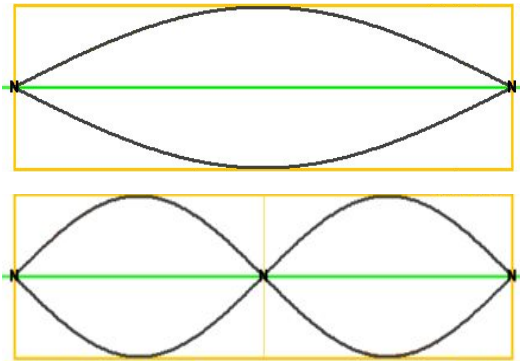



# Pulse transmission

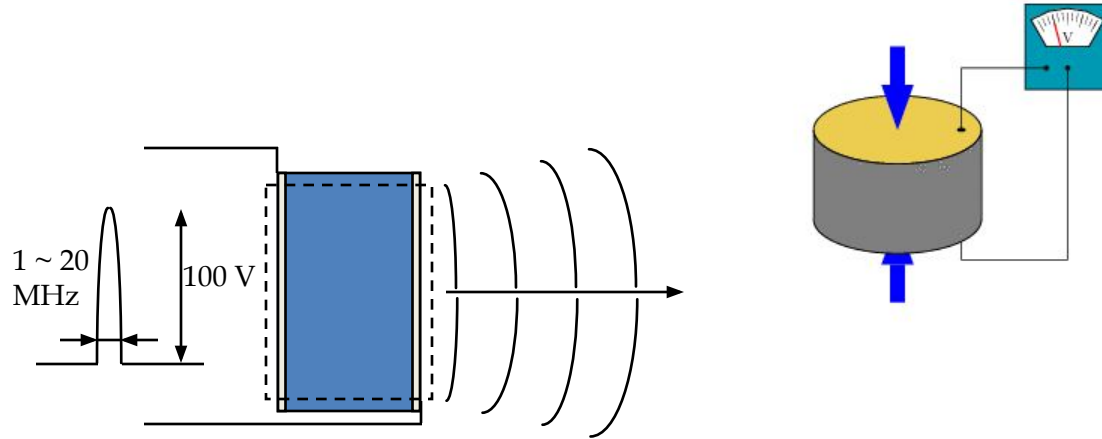

**A-mode**

# Pulse receiving

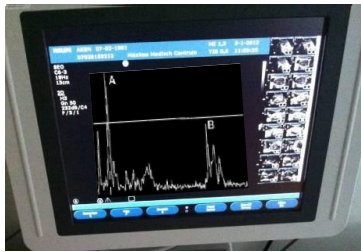
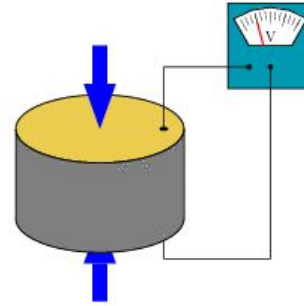
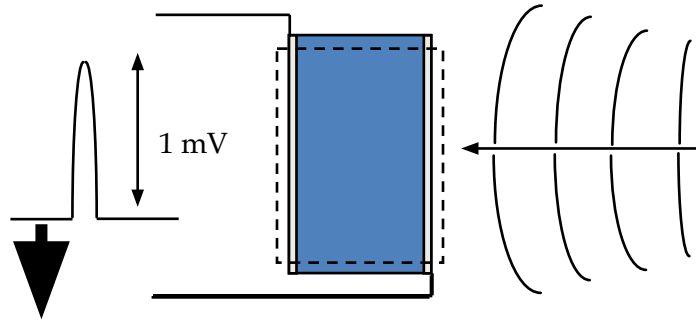

Display on monitor

# Ultrasound transducer (probe)

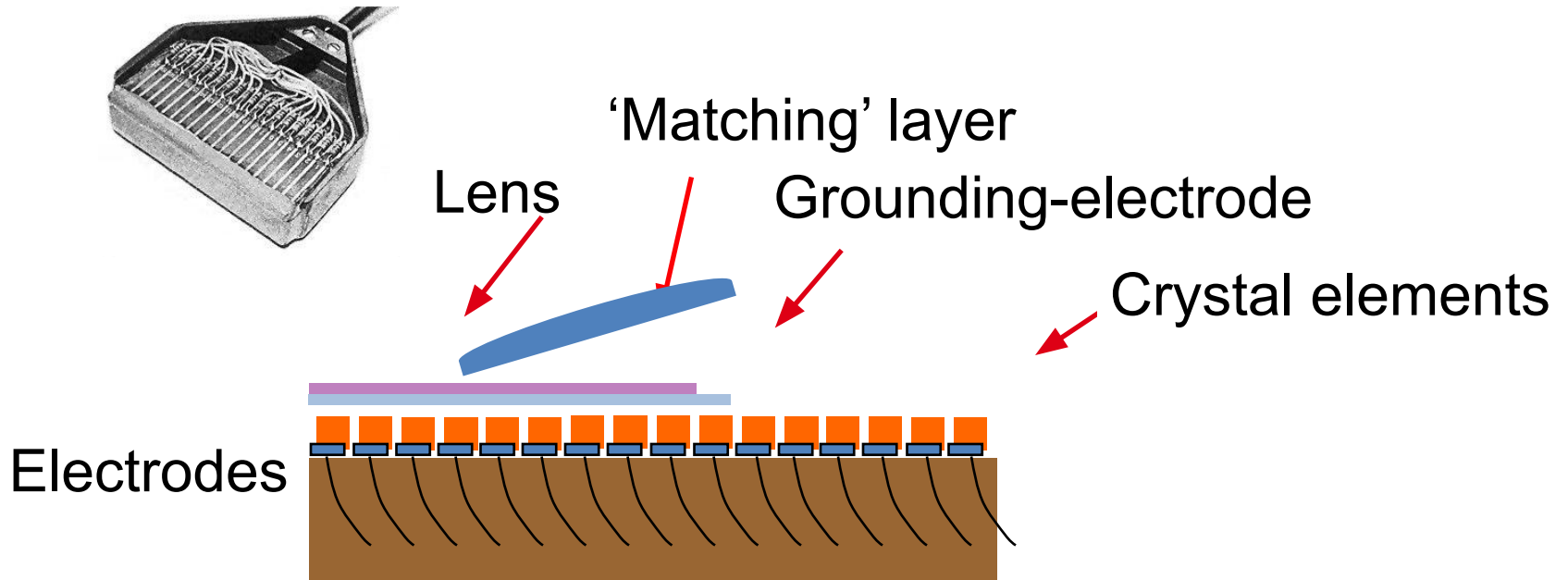

# From US to image

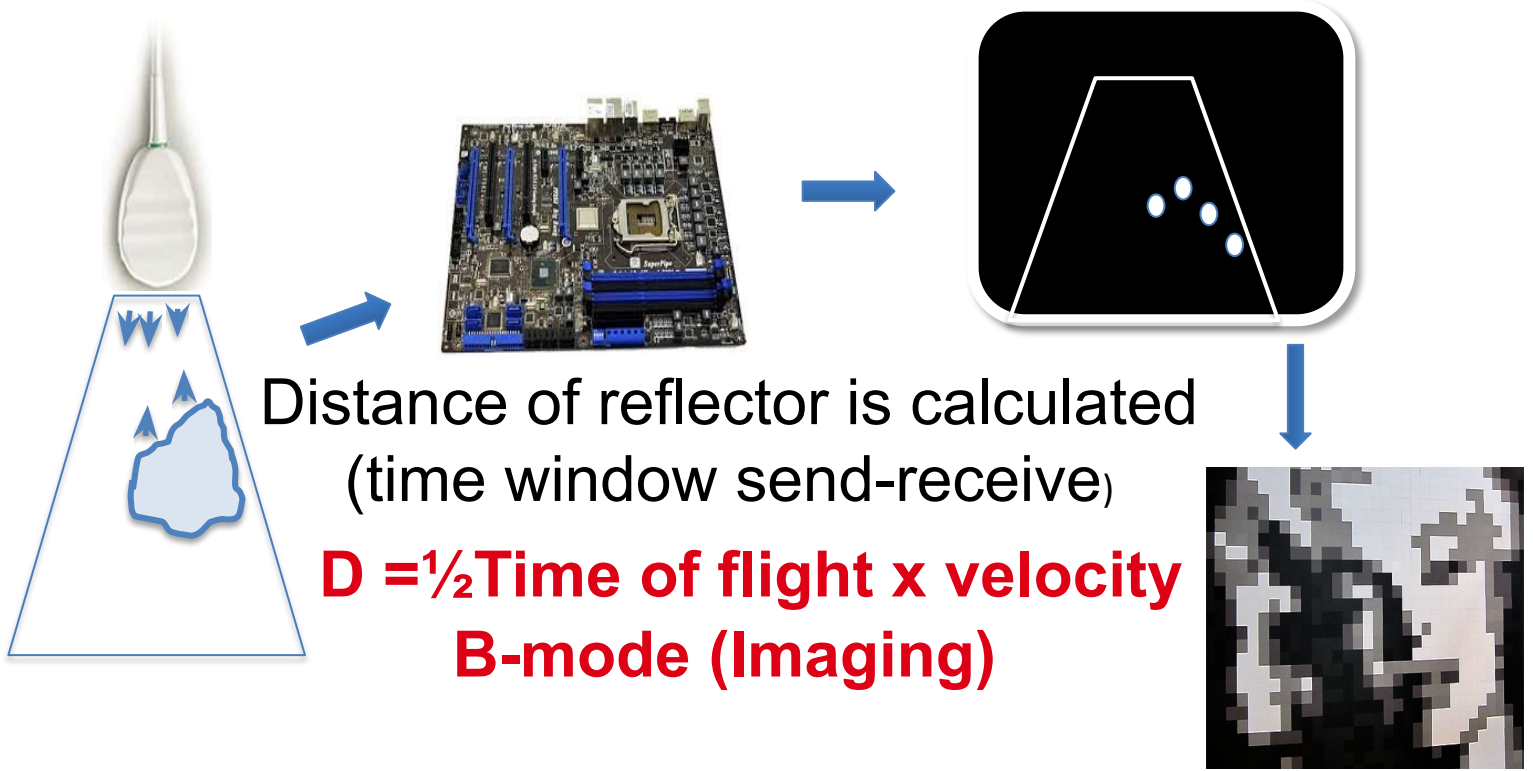

# From US to image

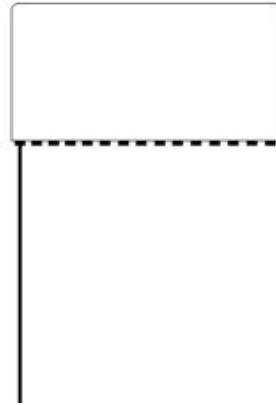

*Styglis*

# From US to image

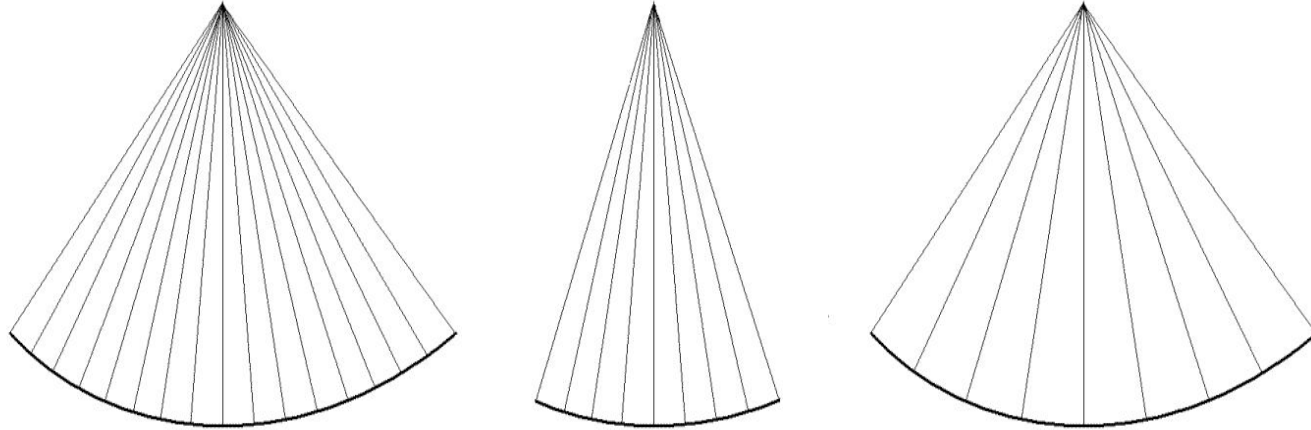

Large angle / width takes time!  
Large number of sectors takes time!

# From US to image

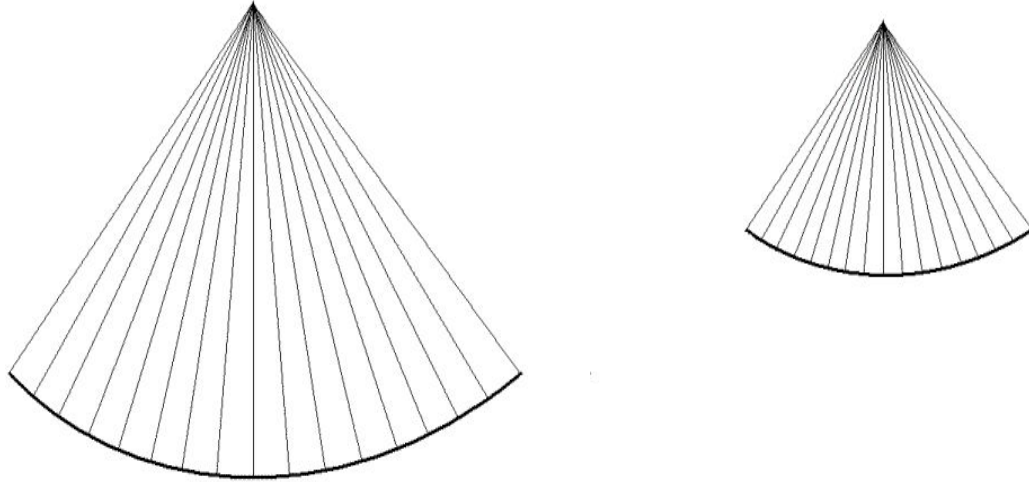

Depth takes time!

# From US to image

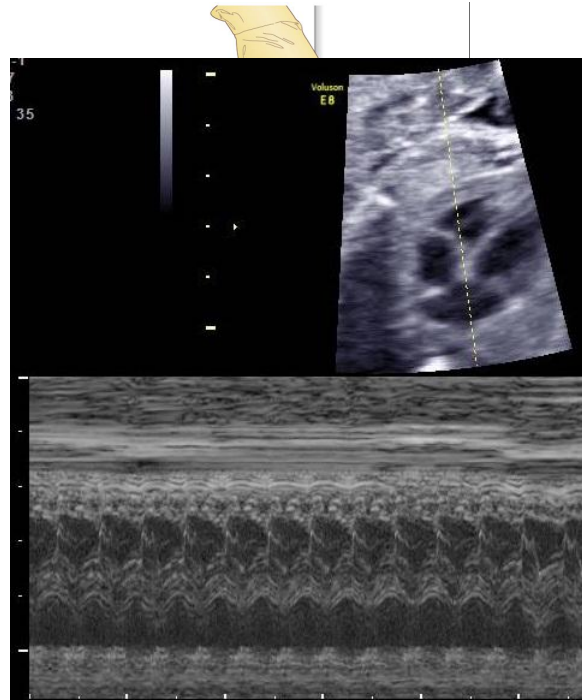

The variations in a single line of echoes are recorded against time

**M-Mode (Motion)**



Time

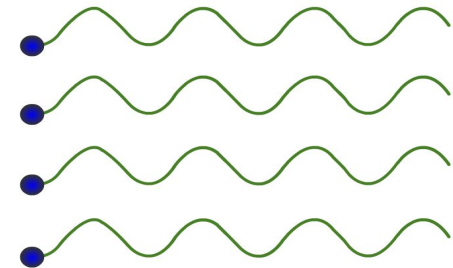



# Frequency, resolution & penetration

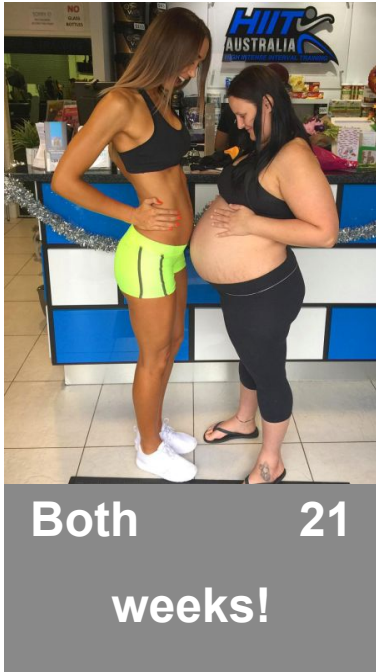

- Low frequency:
  - Less resolution
  - More penetration
- High frequency:
  - High resolution
  - Less penetration

3.5 mHz	=	10-20 cm
5.0 mHz	=	5-10 cm
7.5 mHz	=	2-5 cm
10.0 mHz	=	1-4 cm

# Image - resolution

- Lateral resolution
- Axial resolution
- Temporal resolution

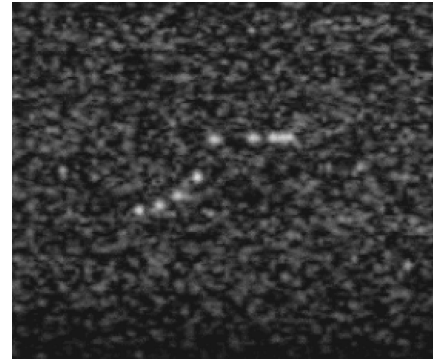
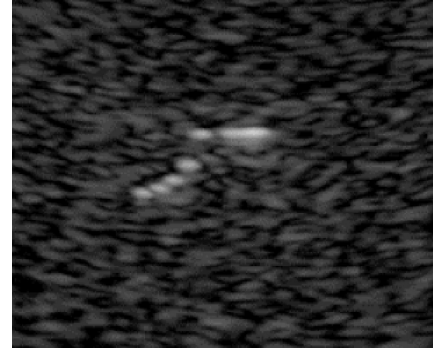

# Image enhancement

## Tissue harmonic imaging

- $2f$ ,  $3f$ ,  $4f$  : laws of physics
- Probe also able to receive harmonic frequencies

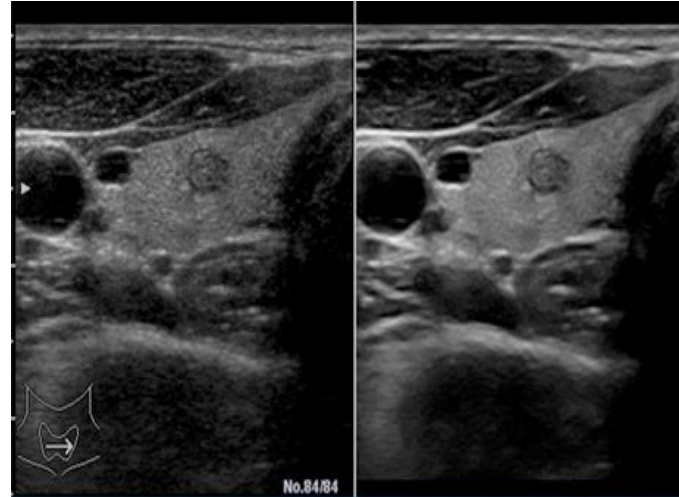
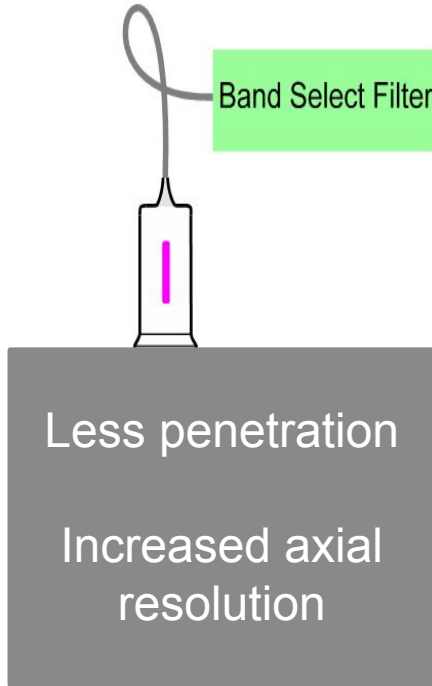

# Artefacts



An ultrasound image which does not match actual anatomy

# Artefacts

## Drop out/ acoustic shadowing



- Dark area posterior to dense reflector
- Most marked along US beam

Reduce/remove by adjusting angle of insonation

# Artefacts

## Posterior enhancement/amplification

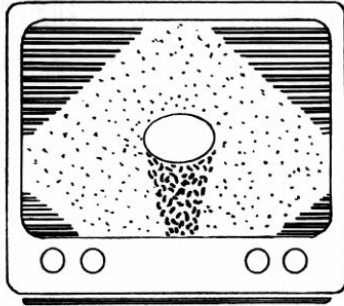

- Area of increased brightness immediately posterior to cystic structure
- Caused by lack in sound attenuation through a structure with few interfaces

**Confirm by changing angle of insonation**

# Artefacts

## Reverberation

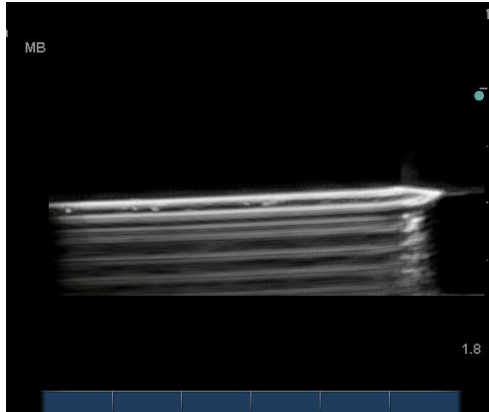
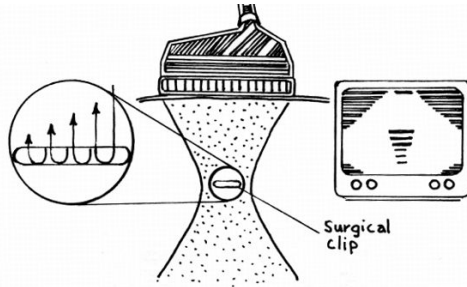

- Occurs when US beam encounters 2 strong parallel reflectors
- Multiple parallel echoes result from back-and-forth travel of US between 2 reflecting surfaces

Change angle of insonation

# Artefacts

## Reverberation

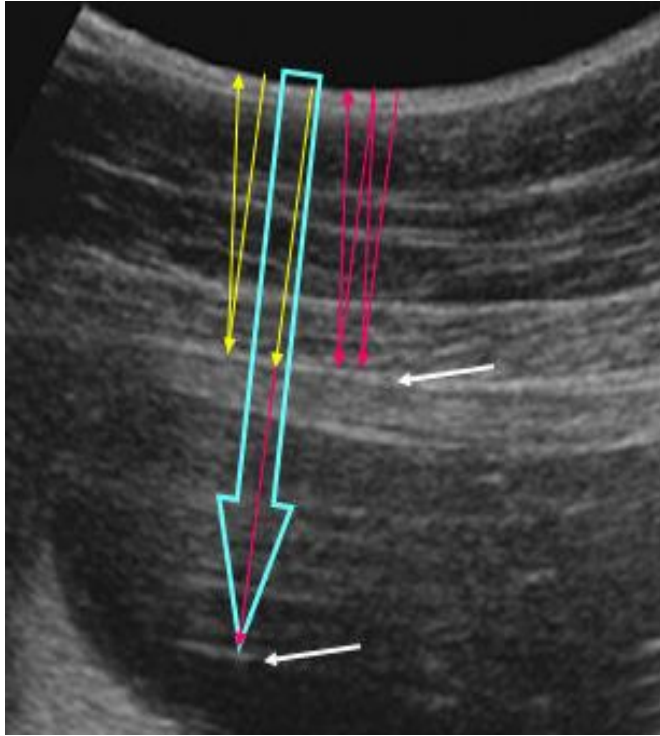

- Probe face & subcutaneous tissue interface provide parallel reflectors

Change angle of insonation



# Artefacts

## Side lobe artifact

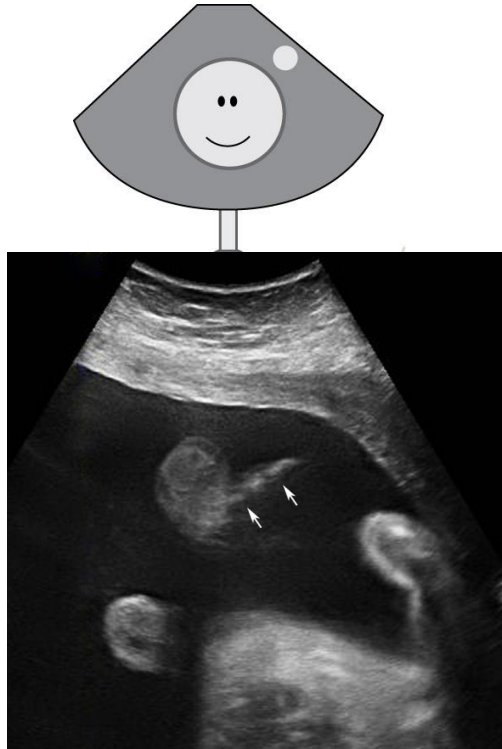

- Results from strong reflector that lies outside the incident beam, but within side lobe of central beam
- Echoes from reflector are displayed as if originating from within central beam

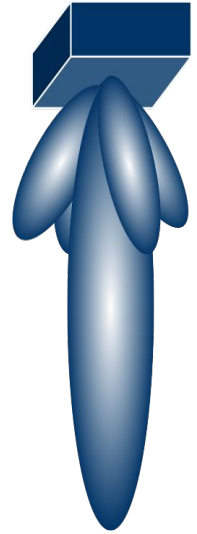

# Safety issues – biological effects

- Increased movement of molecules -> results in rise in temperature
- Gas bubble can collapse (cavitation) -> results in pressure wave released into the surrounding tissue

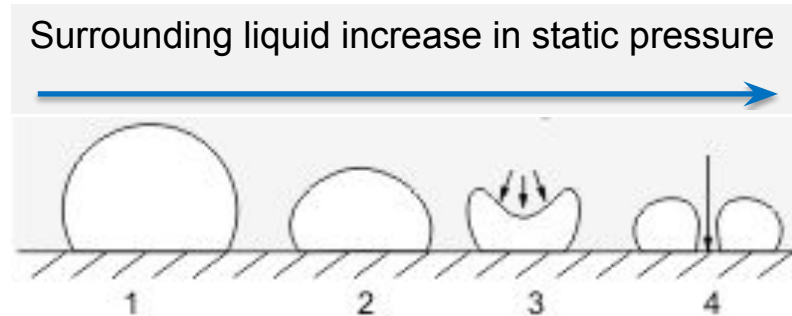

# Safety issues – TI, MI & ALARA

- Thermal Index = TI (<1.0)  
(power needed to increase temperature by 1 °C)
- Mechanical Index = MI (<1.0)
- ALARA principle - as low as reasonably achievable

# Scanning times & TI

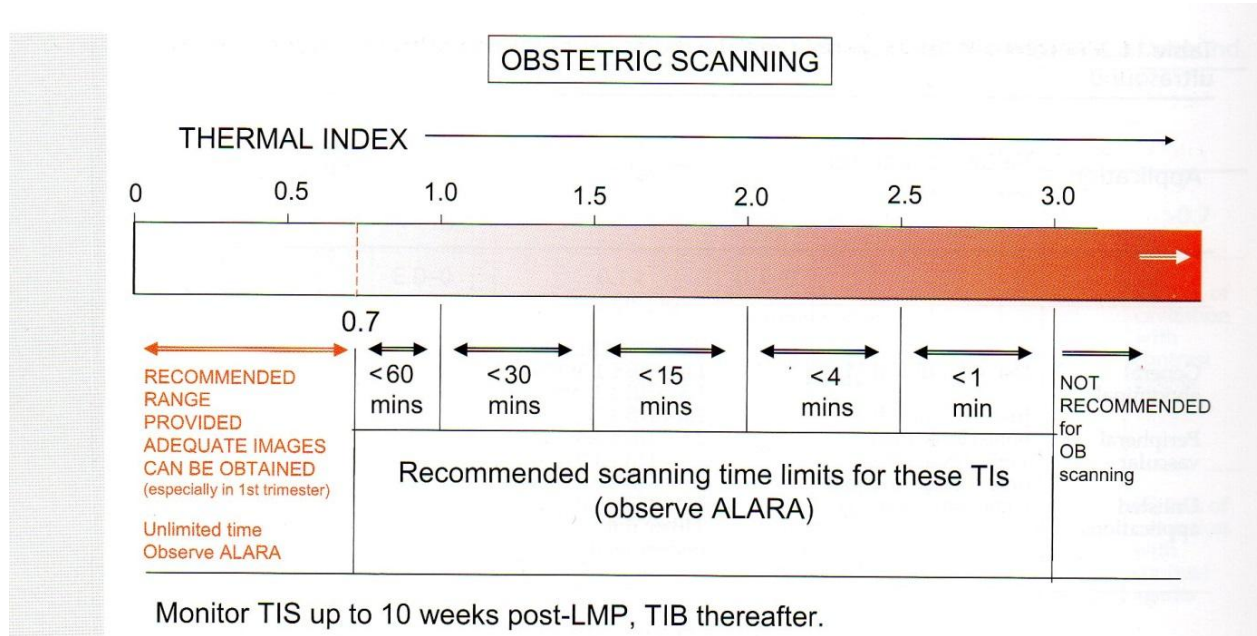

The Safe Use of Ultrasound in Medical Diagnosis (3<sup>rd</sup> ed): 2012; The British Institute of Radiology ,154.

# Safety issues - power levels

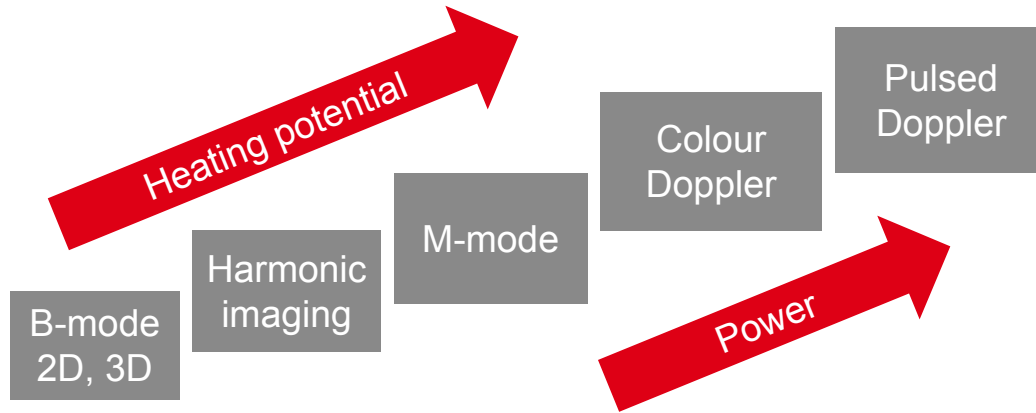

# Safety statements

- International Society Ultrasound in Obstetrics & Gynecology (ISUOG)

<http://www.isuog.org/StandardsAndGuidelines/Statements+and+Guidelines/Safety+Statements/>

- British Medical Ultrasound Society (BMUS)

[https://www.bmus.org/static/uploads/resources/STATEMENT\\_ON\\_THE\\_SAFE\\_USE\\_AND\\_POTENTIAL\\_HAZARDS\\_OF\\_DIAGNOSTIC\\_ULTRASOUND.pdf](https://www.bmus.org/static/uploads/resources/STATEMENT_ON_THE_SAFE_USE_AND_POTENTIAL_HAZARDS_OF_DIAGNOSTIC_ULTRASOUND.pdf)

- American Institute of Ultrasound in Medicine (AIUM)

<http://www.aium.org/resources/statements.aspx>

# Key points

1. Understand how an ultrasound beam produces an image
2. Recognise artefacts, and know how to avoid them
3. Understand the factors important to obtain an optimal Doppler signal
4. Be aware of the principles behind TI and MI



ISUOG Basic Training by [ISUOG](https://www.isuog.org) is licensed under a [Creative Commons Attribution-NonCommercial-NoDerivatives 4.0 International License](https://creativecommons.org/licenses/by-nc-nd/4.0/).

Based on a work at <https://www.isuog.org/education/basic-training.html>.

Permissions beyond the scope of this license may be available at <https://www.isuog.org/>



# Learning objectives

At the end of the lecture you will be able to:

- Explain how an ultrasound image is generated
- Describe the different ultrasound modes used for imaging
- Describe the current international safety standards relating to the thermal index (TI) and the mechanical index (MI)

# Key questions

1. What is ultrasound?
2. How is a B-mode real time image produced?
3. How should the ALARA principle be applied?

# Sound/Ultrasound

- Longitudinal mechanical wave
- Transmitted through medium by local displacement of particles within medium – compression & rarefaction
- Frequency (Hertz) = cycles/sec
- Human audible range = 20Hz – 20,000Hz (20kHz)
- Ultrasound = frequencies above audible range

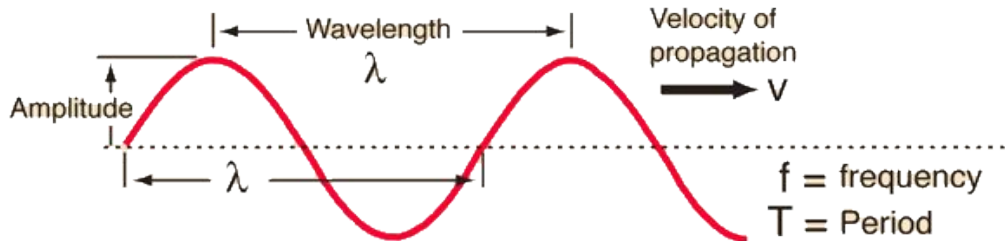

# Sound

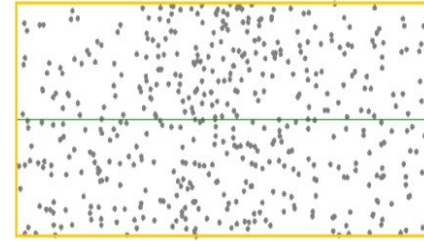

- Compressional wave
- Gas, liquid or solid medium
- Speed of sound depends on medium and temperature
  - Air 343 m/s
  - Water 1482 m/s
  - Steel 5960 m/s
  - **Average in biological tissue 1540 m/s**

# Physics of sound

- Medical US ~ 1 – 20 MHz

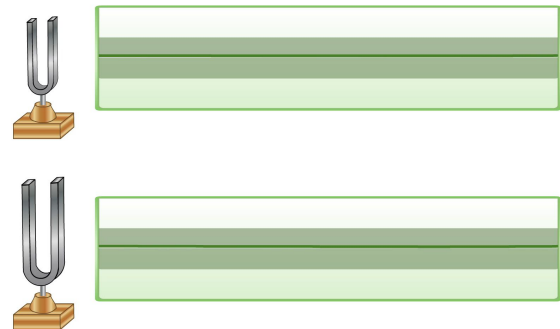
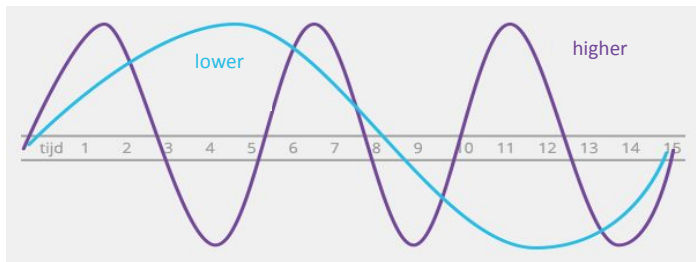
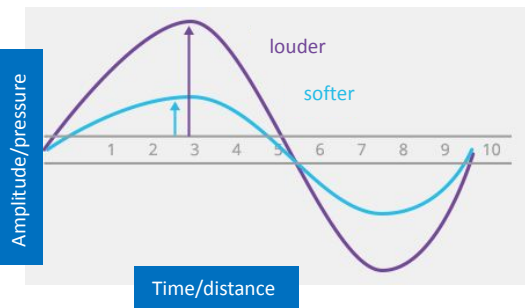
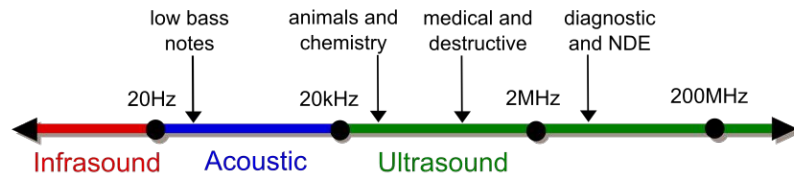
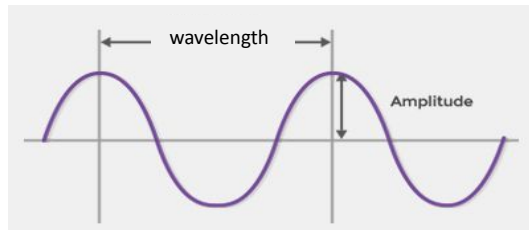

# From US to image

- Piezoelectric effect – ability to generate (transduce) electrical charge in response to applied mechanical stress, & vice versa
- Piezoelectric crystal - quartz, zirconium titanate, modern ceramics

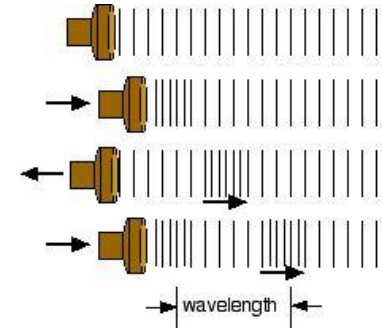
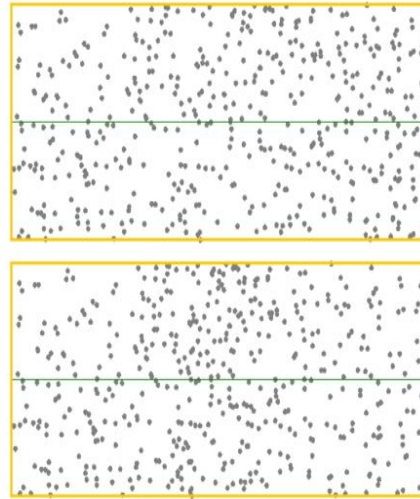
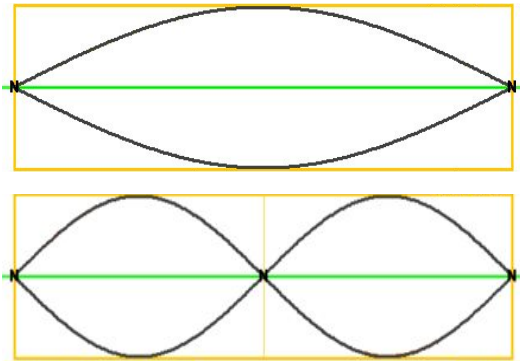

# Pulse transmission

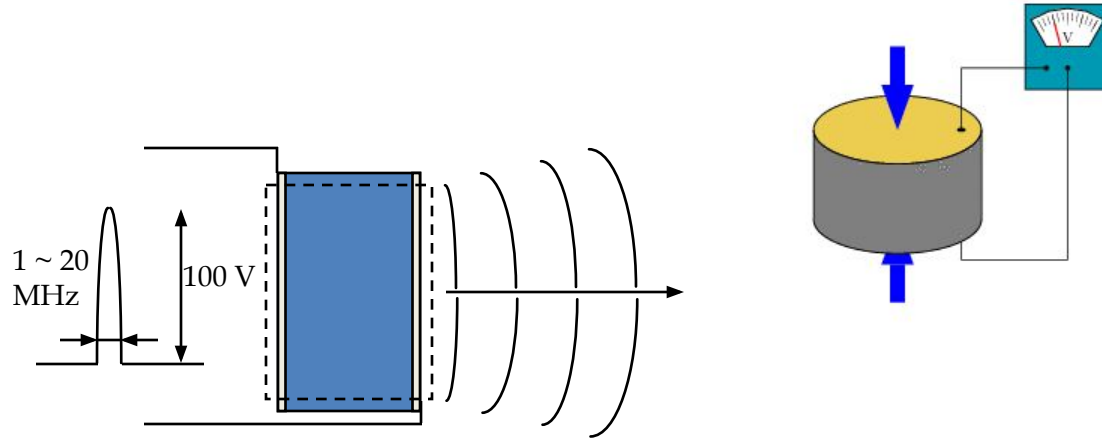

**A-mode**

# Pulse receiving

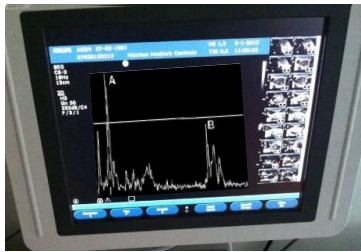
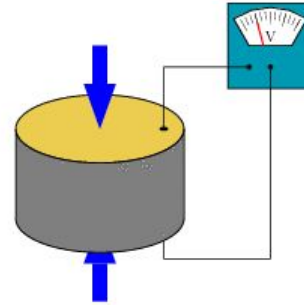
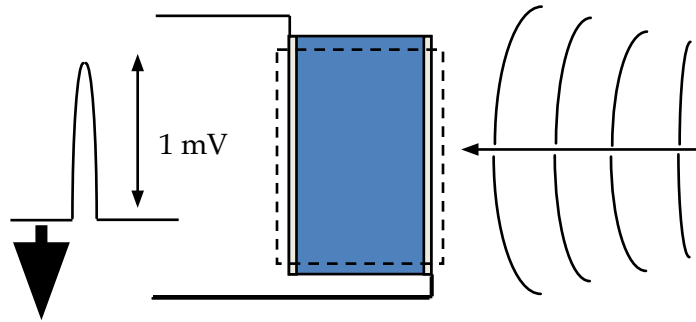

Display on monitor



# Ultrasound transducer (probe)

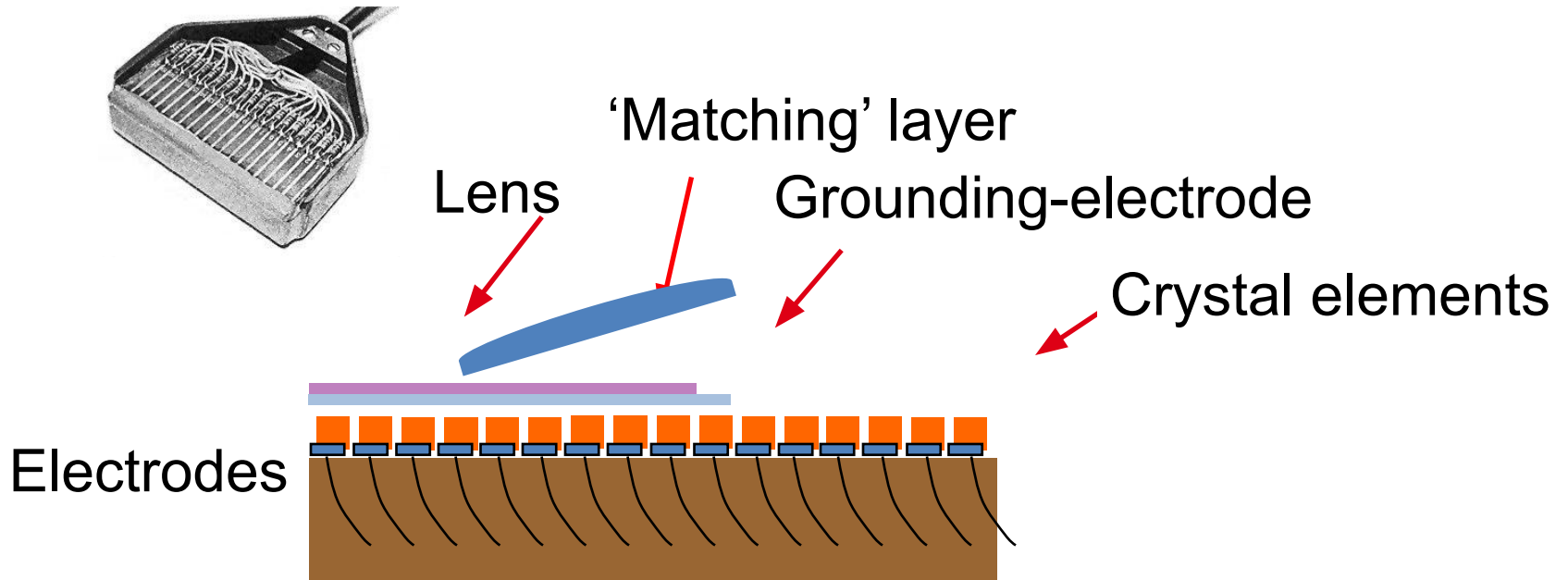

# From US to image

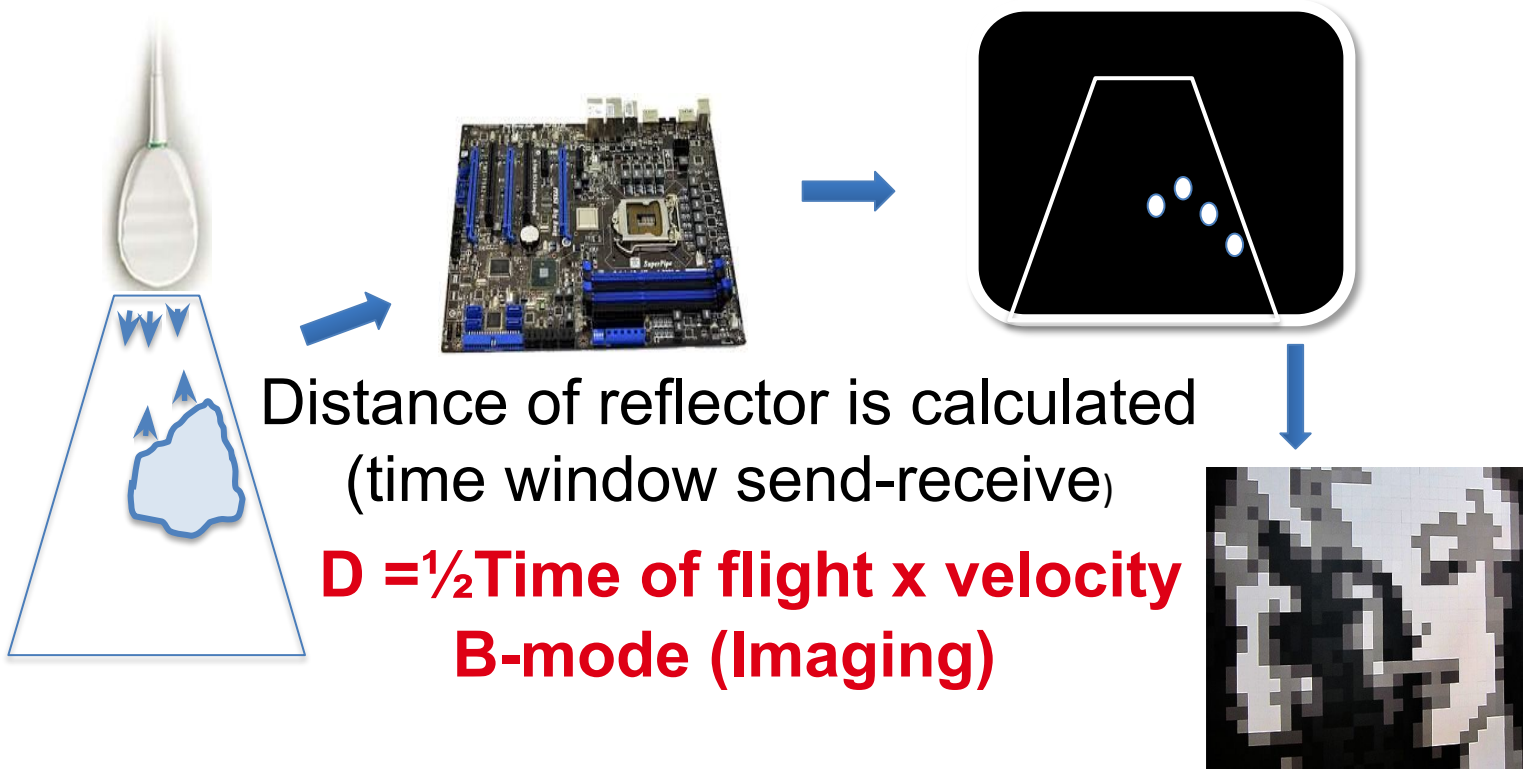

# From US to image



*Stygen*

# From US to image

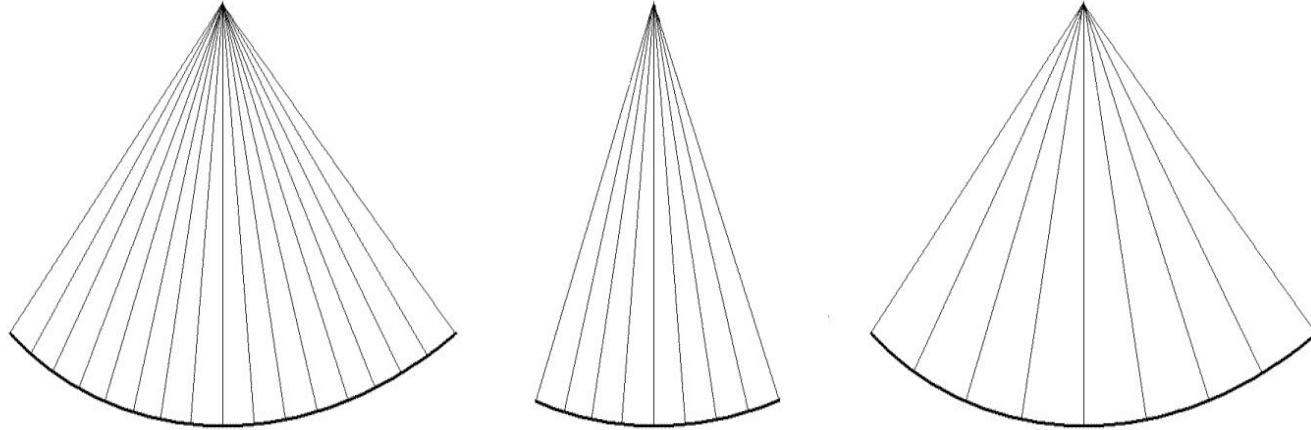

Large angle / width takes time!  
Large number of sectors takes time!

# From US to image

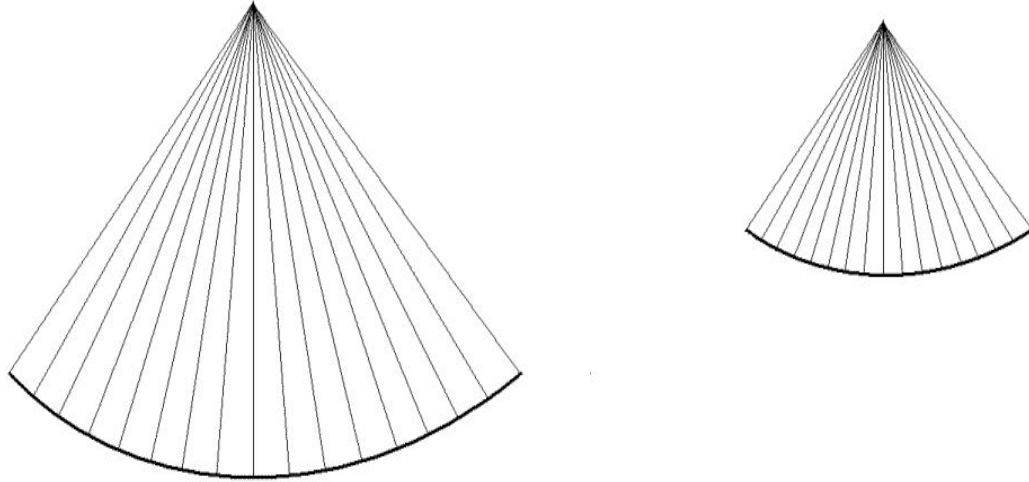

Depth takes time!

# From US to image

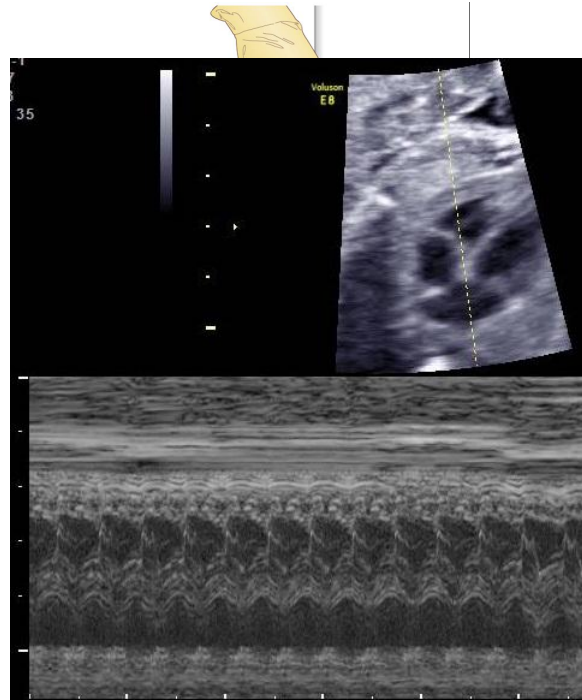

The variations in a single line of echoes are recorded against time

**M-Mode (Motion)**

Time

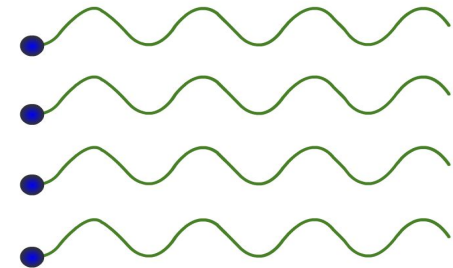

# Frequency, resolution & penetration

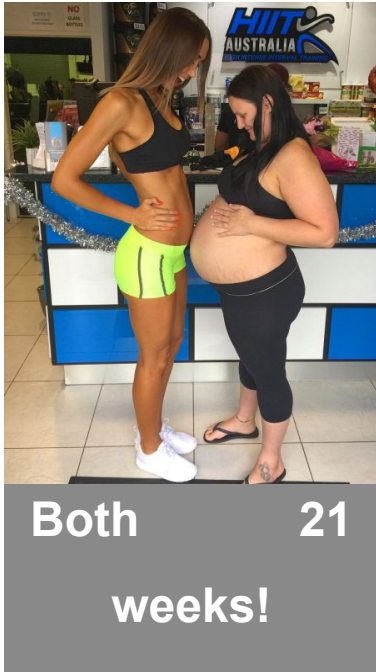

- Low frequency:
  - Less resolution
  - More penetration
- High frequency:
  - High resolution
  - Less penetration

3.5 mHz	=	10-20 cm
5.0 mHz	=	5-10 cm
7.5 mHz	=	2-5 cm
10.0 mHz	=	1-4 cm

# Image - resolution

- Lateral resolution
- Axial resolution
- Temporal resolution

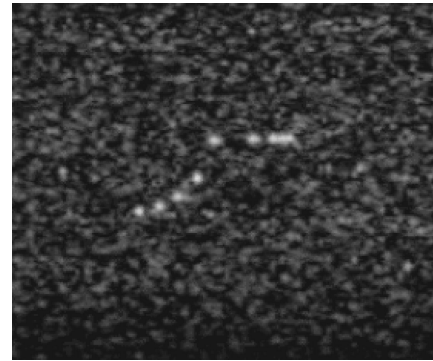
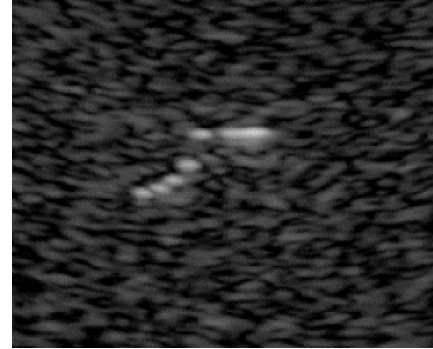



# Image enhancement

## Tissue harmonic imaging

- $2f$ ,  $3f$ ,  $4f$  : laws of physics
- Probe also able to receive harmonic frequencies

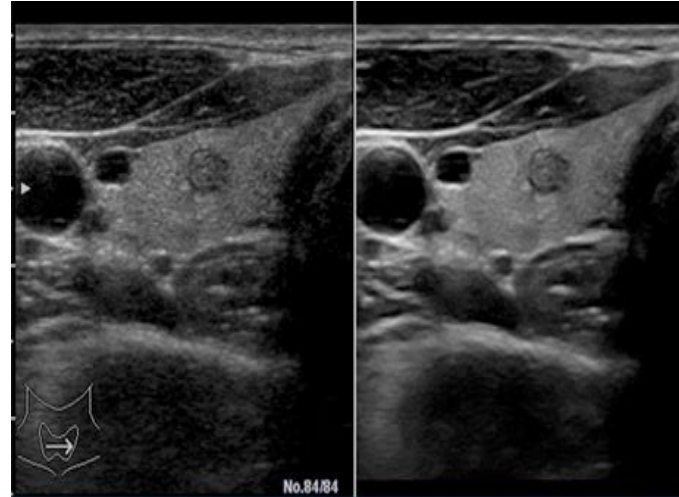
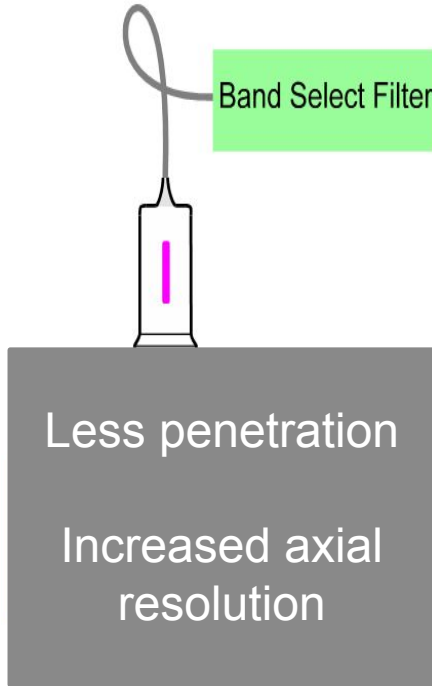

# Artefacts



An ultrasound image which does not match actual anatomy

# Artefacts

## Drop out/ acoustic shadowing



- Dark area posterior to dense reflector
- Most marked along US beam

Reduce/remove by adjusting angle of insonation

# Artefacts

## Posterior enhancement/amplification

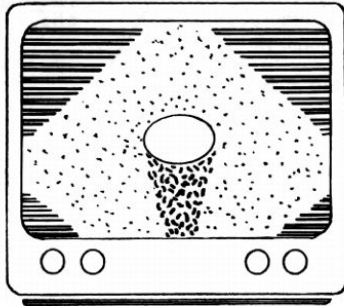

- Area of increased brightness immediately posterior to cystic structure
- Caused by lack in sound attenuation through a structure with few interfaces

**Confirm by changing angle of insonation**

# Artefacts

## Reverberation

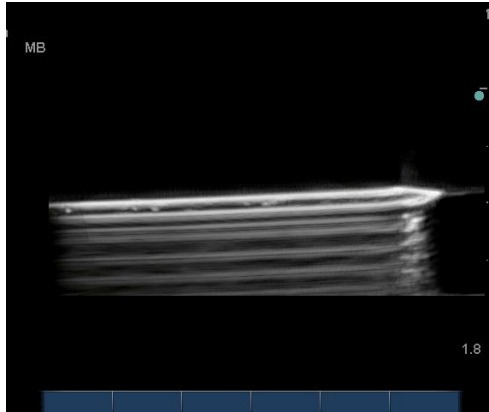
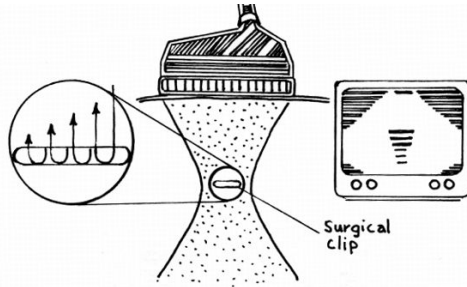

- Occurs when US beam encounters 2 strong parallel reflectors
- Multiple parallel echoes result from back-and-forth travel of US between 2 reflecting surfaces

Change angle of insonation

# Artefacts

## Reverberation

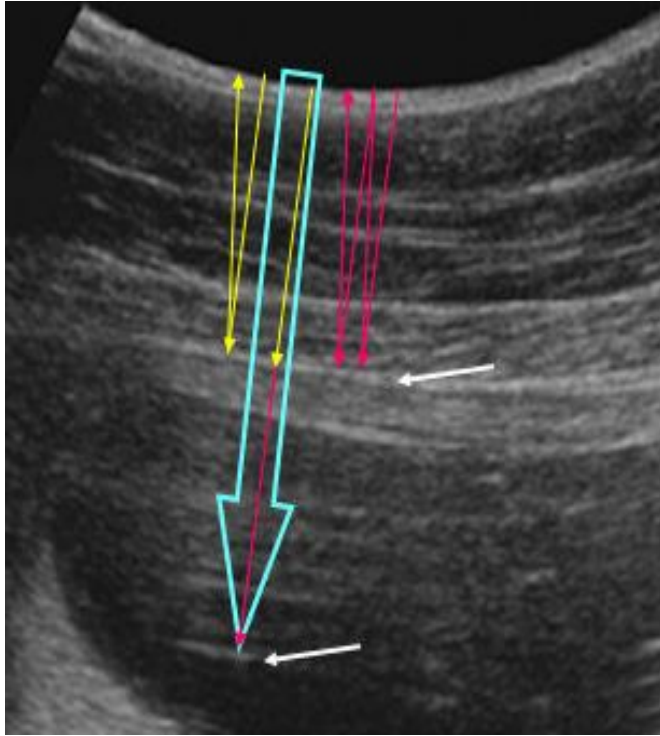

- Probe face & subcutaneous tissue interface provide parallel reflectors

Change angle of insonation

# Artefacts

## Side lobe artifact

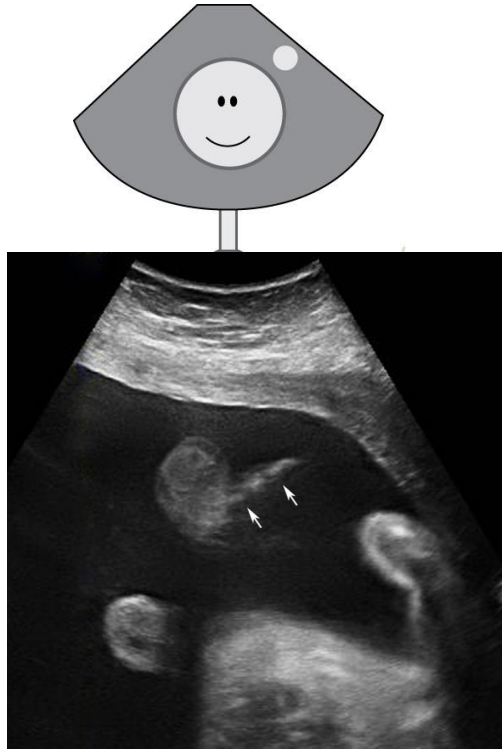

- Results from strong reflector that lies outside the incident beam, but within side lobe of central beam
- Echoes from reflector are displayed as if originating from within central beam

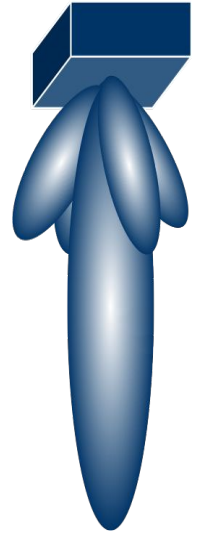

# Safety issues – biological effects

- Increased movement of molecules -> results in rise in temperature
- Gas bubble can collapse (cavitation) -> results in pressure wave released into the surrounding tissue

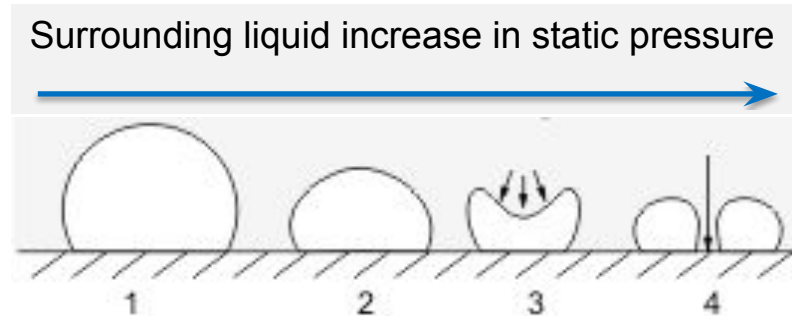



# Safety issues – TI, MI & ALARA

- Thermal Index = TI (<1.0)  
(power needed to increase temperature by 1 °C)
- Mechanical Index = MI (<1.0)
- ALARA principle - as low as reasonably achievable

# Scanning times & TI

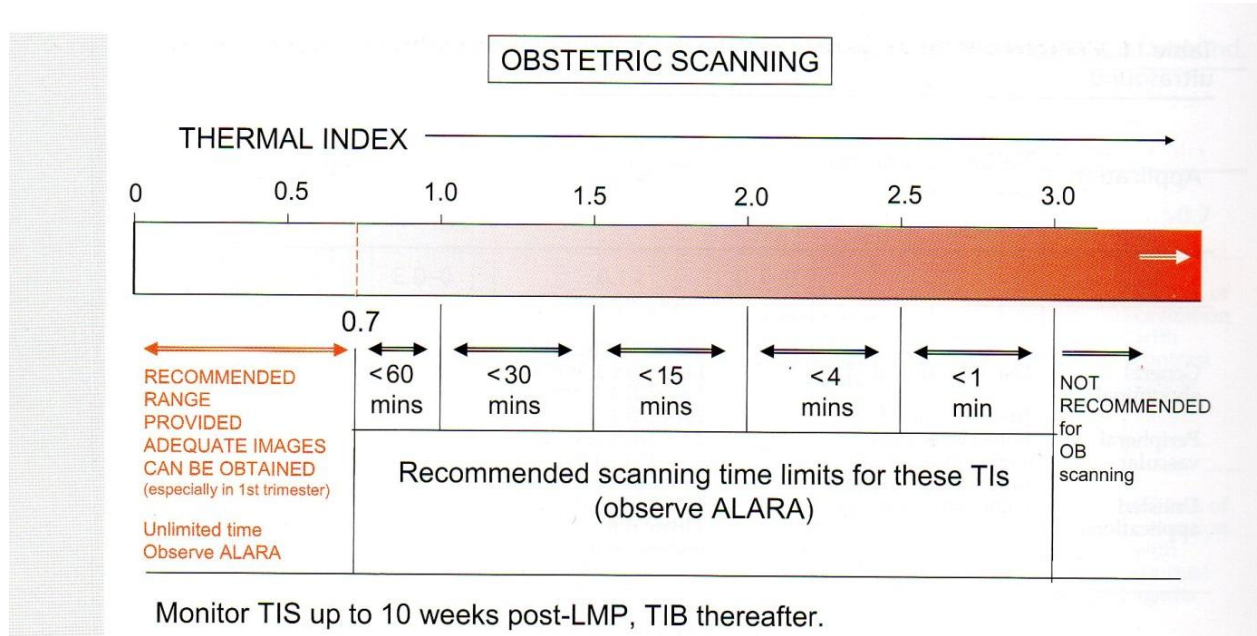

The Safe Use of Ultrasound in Medical Diagnosis (3<sup>rd</sup> ed): 2012; The British Institute of Radiology ,154.

# Safety issues - power levels

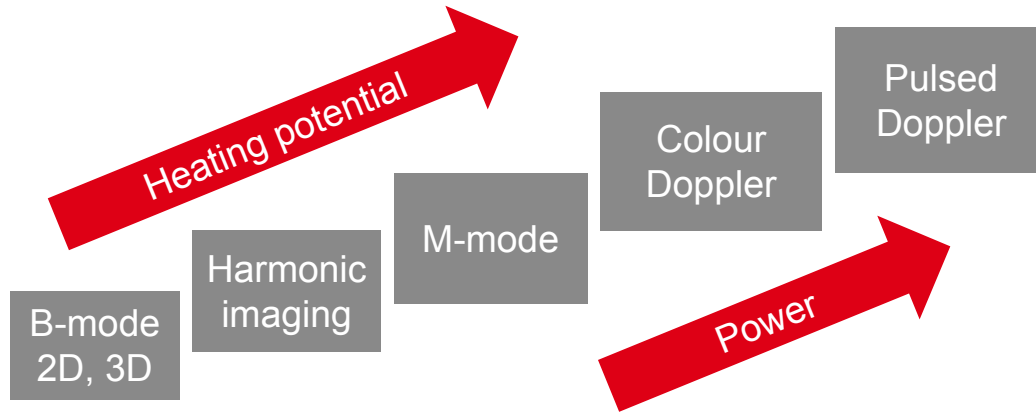

# Safety statements

- International Society Ultrasound in Obstetrics & Gynecology (ISUOG)

<http://www.isuog.org/StandardsAndGuidelines/Statements+and+Guidelines/Safety+Statements/>

- British Medical Ultrasound Society (BMUS)

[https://www.bmus.org/static/uploads/resources/STATEMENT\\_ON\\_THE\\_SAFE\\_USE\\_AND\\_POTENTIAL\\_HAZARDS\\_OF\\_DIAGNOSTIC\\_ULTRASOUND.pdf](https://www.bmus.org/static/uploads/resources/STATEMENT_ON_THE_SAFE_USE_AND_POTENTIAL_HAZARDS_OF_DIAGNOSTIC_ULTRASOUND.pdf)

- American Institute of Ultrasound in Medicine (AIUM)

<http://www.aium.org/resources/statements.aspx>

# Key points

1. Understand how an ultrasound beam produces an image
2. Recognise artefacts, and know how to avoid them
3. Understand the factors important to obtain an optimal Doppler signal
4. Be aware of the principles behind TI and MI



ISUOG Basic Training by [ISUOG](https://www.isuog.org) is licensed under a [Creative Commons Attribution-NonCommercial-NoDerivatives 4.0 International License](https://creativecommons.org/licenses/by-nc-nd/4.0/).

Based on a work at <https://www.isuog.org/education/basic-training.html>.

Permissions beyond the scope of this license may be available at <https://www.isuog.org/>